

INSTRUCTION MANUAL

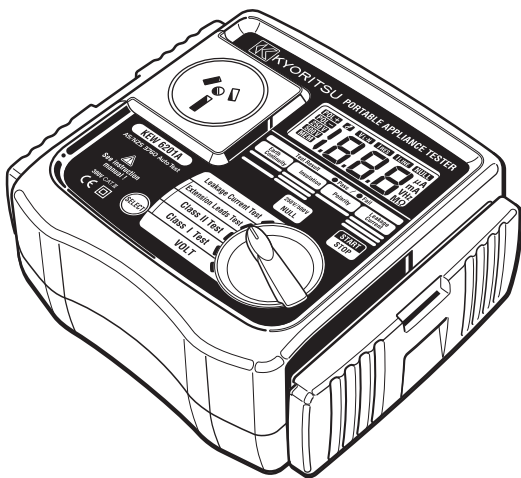

PORTABLE APPLIANCE TESTER

KEW6201A



**KYORITSU ELECTRICAL
INSTRUMENTS WORKS, LTD.**

CONTENTS

1. Safe testing	1
2. Procedure of removing cover	3
2.1 Method of removing the cover	3
2.2 Method of storing the cover	3
3. Product summary and explanation	4
3.1 Product summary	4
3.2 Test range	4
3.3 Features	5
3.4 Instrument layout	5
3.5 Explanation for indications	8
3.6 Applicable standards	8
4. Specification	9
4.1 General specification, measuring range and accuracy	9
4.2 Threshold and display	9
4.3 Reference test condition	10
5. Preparation before a measurement	11
5.1 Visual inspection	11
5.2 Connection to main power supply	11
5.2.1 Connection of mains cord	11
5.2.2 Check the power supply voltage	11
5.2.3 Null setting (Protective conductor resistance function)	12
5.2.4 Voltage setting for insulation resistance measurement	13
6. Measuring method	14
6.1 Class I Test	14
6.2 Class I Test (Select the Leakage current test)	16
6.3 Class II Test	17
6.4 Class II Test (Select the Leakage current test)	18
6.5 Extension Leads Test	20
6.6 Leakage Current Test	23
7. Fuse replacement	24
8. Services	25
9. Case and strap assembly	25

1. Safe testing

Electricity is dangerous and can cause injury and death. Always treat it with the greatest of respect and care. If you are not quite sure how to proceed, stop a measurement and take advice from a qualified person.

This instruction manual contains warning and safety rules which must be observed by the user to ensure safe operation of the instrument and retain it in safe condition. Therefore, read through these operating instructions before using the instrument.

IMPORTANT:

This instrument must only be used by a competent and trained person and operated in strict accordance with the instructions.

KYORITSU will not accept liability for any damage or injury caused by misuse or non-compliance with the instructions or with the safety procedures.

It is essential to read and to understand the safety rules contained in the instructions or with the safety procedures.

The symbol \triangle indicated on the instrument means that the user must refer to the related sections in the manual for safe operation of the instrument.

Be sure to carefully read instructions following each symbol \triangle in this manual.

\triangle DANGER is reserved for conditions and actions that are likely to cause serious or fatal injury.

\triangle WARNING is reserved for conditions and actions that can cause serious or fatal injury.

\triangle CAUTION is reserved for conditions and actions that can cause minor injury or instrument damage.

⚠ DANGER

- This instrument can be connected only to the commercial power of 240V+10%-10%, 50Hz.
- For safety reasons, only use the Test Leads designed to be used with this instrument and recommended by KYORITSU.
- Use only grounded mains outlets to supply the instrument.
Do not touch the device under test while testing is in progress.
- Since a high voltage of 500V is outputting continuously, especially while measuring insulation resistance, user may get electrical shock. Also not to touch the capacitor of the device under test as hazardous voltage may exist.
- When testing, always be sure to keep your fingers behind the safety barriers on the test leads.
- Disconnect the instrument from the power supply when measurement is finished.
- Do not leave the instrument with connected to the power supply.
- Be sure to use the instrument only in its intended applications and to follow measurement procedures described in the manual.
- The instrument should be used only in its intended applications or conditions. Otherwise, safety functions equipped with the instrument do not work, and instrument damage or serious personal injury may be caused.
- Verify proper operation on a known source before use or taking action as a result indication of the instrument.
- It is essential that the above instructions are adhered to. Failure to follow the above instructions may cause injury, instrument damage and/or damage to equipment under test. Kyoritsu is by no means liable for any damage resulting from the instrument in contradiction to these cautionary notes.

⚠ WARNING

- Never open the instrument case – because dangerous voltages are present. Only fully trained and competent electrical engineers should open the case.
- If abnormal conditions of any sort are noted (such as a faulty display, unexpected readings, broken case, cracked test leads, etc) do not use the instrument and return it to your distributor for inspection and repair.
- Never attempt to use the instrument if the instrument or your hand is wet.
- This instrument isn't dust & water proofed. Keep away from dust and water.
- Do not install substitute parts or make any modification to the instrument. Return the instrument to Kyoritsu or your distributor for repair or re-calibration.
- Never attempt to make any measurements if the test lead or the instrument has any structural abnormality, such as a crack, or if the cover is not securely attached.

⚠ CAUTION

- When using Test Leads with alligator clip, be sure to check the alligator clip is firmly connected to the metal part of the device under test. Otherwise, inaccurate measurement or arc at the contacts may occurs.
- The rated measuring voltage for insulation test is 500V.DC. For electrical devices to be tested, if this test voltage seems not proper to apply, contact your distributor and ask for advices.
- When testing faulty device, it may trip the circuit breaker of main power supply during test and may cause interruption of service. Be careful when the same main power supply is used for PCs.
- We are not liable for loss of data on PC during testing with this instrument. The device under test (DUT) is powered on during most tests, but please turn it to OFF position after use.
- Use a cloth dipped in water or neutral detergent for cleaning the instrument. Do not use abrasives or solvents.

2. Procedure of removing cover

KEW 6201A have a dedicated cover to protect against an impact from the outside and prevent the operation part, the LCD, and the connector socket from becoming dirty. The cover can be detached and put on the back side of the main body during measurement.

2.1 Method of removing the cover

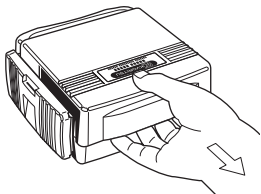

Fig. 1

2.2 Method of storing the cover

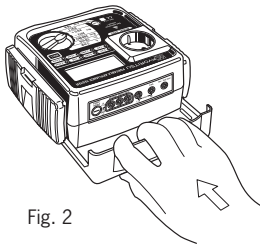

Fig. 2

3. Product summary and explanation

3.1 Product summary

The KEW 6201A is a hand-held portable appliance tester, performing four functions to ensure the Safety of Class I and Class II appliances. And also can measure the mains voltage. Readings are displayed on a large liquid crystal display (LCD) below which are three LEDs, light up in 2 color, 2 color LEDs which unambiguously display a pass or fail indication for results dictated by international standards.

This instrument is suitable for performing tests as required by the following standards.

AS/NZS 3760 In-service safety inspection and testing of electrical equipment. This instrument is designed to check the electrical safety of appliances of Class I and Class II categories.

As a guide IEC standard define these two categories as follows:

Class I : Appliances which have a functional insulation throughout and an earth connected case. These are often described as earthed appliances.

Class II: Appliances which have both functional and additional insulation where any metal parts cannot become “Live” under fault conditions.

3.2 Test Function

KEW6201A have following features.

Function	Tests of contents
Class I Test	<ul style="list-style-type: none">•Protective conductor resistance•Insulation (250V or 500V)
SELECT Switch + Class I Test	<ul style="list-style-type: none">•Protective conductor resistance•Leakage Current test
Class II Test	<ul style="list-style-type: none">•Insulation (250V or 500V)
SELECT Switch + Class II Test	<ul style="list-style-type: none">•Leakage Current test
Extension Leads test	<ul style="list-style-type: none">•Protective conductor resistance•Insulation P/N-PE•Polarity
SELECT Switch + Extension Leads test	<ul style="list-style-type: none">•Protective conductor resistance•Leakage Current test
Leakage Current Test	<ul style="list-style-type: none">•Leakage current measurement

3.3 Features

- Warning for the appliance to be ON.
- Selection for 250V or 500V on the insulation resistance test.
- Null function for the protective conductor resistance test.
- Warning for the over range value in the LCD.
- Capable of judging pass/fail of tests by LED on the panel and by buzzer.

3.4 INSTRUMENTS LAYOUT

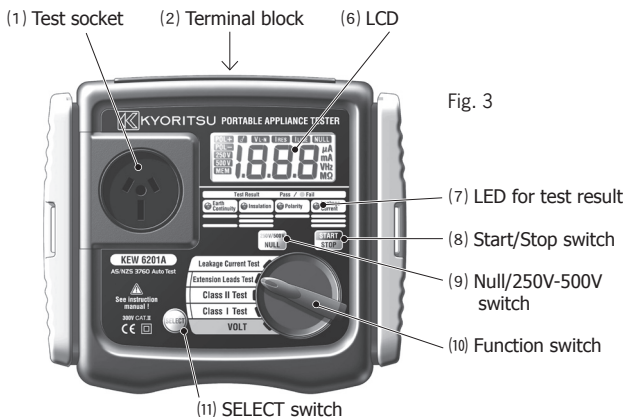

Terminal Block

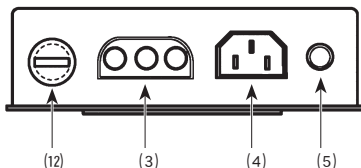

(1) Test socket

Insert the mains plug of DUT to this socket for the polarity test of protective conductor resistance, insulation resistance and Leakage current test.

- (2) Terminal block
Connect the attached mains cord and Test Leads to this terminal block.
- (3) Terminal for mains cord
This terminal is connected to a mains supply via M7123.
- (4) Terminal for Extension leads adaptor
It corresponds to L, N, E of test socket, and the extension leads adaptor (M-7140) connected with the cord reel to be plugged to it.
- (5) PE-probe terminal
Connect the Test Lead with alligator clip (M-7129A)(13) to this terminal for the measurement of protective conductor resistance, and clip the metal parts of DUT with the alligator clip.
- (6) LCD
Measured value is displayed
- (7) LED for test result
When the value of protective conductor resistance and insulation resistance exceeds the limit dictated by applicable standards, LED lights up in red. When it is within the limit, LED lights up in green.
- (8) Start/Stop switch
A measurement starts by pressing this switch.
Pressing the Start/Stop Switch again during Leakage Current Test stops measurements.
- (9) Null/250V-500V switch
- Class I test measurement
It is used in order to push the Null button before protection earth resistance measurement and to cancel the resistance of a test leads.
 - Class II test measurement
The test voltage of insulation resistance is changed to 500V and 250V.
- (10) Function switch
Select a function with this switch.
- (11) SELECT switch
When the function is set under SELECT switch is pressed, the appliance will be actually operated to measure a leakage current instead of measuring insulation.

(12) Fuse

Protected by a fuse of 600V/10A ceramic fuse (F type $\Phi 6.3 \times 32\text{mm}$).

User can replace this fuse.

Please refer to Section 7 for information on replacement fuse.

(13) Mains cord (AU) M-7123

This mains cord can be connected to the mains supply so that the instrument can derive power from it. To measure contact current, the socket of the main power supply is to be equipped with an earth terminal.

Fig. 4



(14) Test Lead with safety alligator clip(M-7129A) and Probe with Blade type Prod(M-7161A).The adapter of a tip part is exchangeable for an alligator clip and a test stick type.

Please use it according to a measurement use.

Fig. 5

Probe with Blade Type Prod

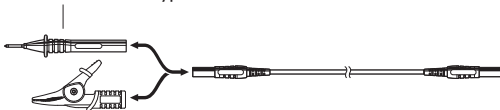

Safety Alligator Clip

(15) Extension leads adaptor(M-7140)

This is for connecting the instrument and a cord reel.

Fig. 6



3.5 Explanation for indications

LCD Display

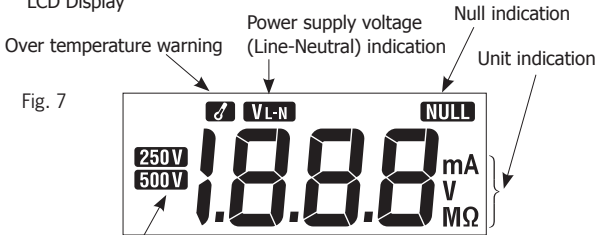

Fig. 7

Insulation measurement voltage

Note) Over range display: “OL” is displayed on the LCD.

Display symbols

	DUT is OFF.		Represents LN-E.
	When leakage current test is interrupted.		Represents leakage current.
	Represents Protective conductor resistance		During the DUT is operated at the leakage current test.
	Represents the test is fail.		Display prompt the user to set the DUT switch on.
	The temperature sensor monitors overheating of the transformer. When the overheat symbol appears on the LCD screen the unit will cease to operate until it cools down to normal operating temperature and the overheat symbol disappears from the screen. Normal operation then resumes.		

3.6 Applicable standards

Instrument operation

AS/NZS 3760 In-service safety inspection and testing of electrical equipment.

Safety: IEC/EN61010-1 CAT.III 300V-instrument

IEC/EN61010-2-030 CAT.III 300V

IEC/EN61010-031 CAT.III 300V(600V)-test lead

4. Specification

4.1 General specification, measuring range and accuracy

Voltage(VOLT) measurement of main power supply

Measuring range	207 ~ 264V AC
Resolution	1V
Accuracy	$\pm (2\%rdg+3dgt)$

Measurement of Protective conductor resistance(RPE)

Measuring range	0 ~ 15.00 Ω
Resolution	10m Ω
Open-circuit voltage	<AC12V
Measuring current	10A AC nominal value
Accuracy	$\pm (3\%rdg+5dgt)$

Measurement of Insulation resistance (RINS)

Rating	250V/20M Ω and 500V / 20M Ω
Measuring range	0.1~19.99M Ω
Resolution	10k Ω
Rated voltage	250V/500V DC(+20%/-10%) @1M Ω
Short-circuit current	2.5mA DC or less
Accuracy	$\pm (2\% rdg+3dgt)$

Leakage current test

Measuring range	AC0.1~ 19.99mArms
Resolution	0.01mA
Accuracy	$\pm(3\%rdg \pm 5dgt)$
Examination time	Max 15 seconds

Note: For MOV appliances use Leakage Current test.

4.2 Threshold and display

Equipment	Protective conductor resistance	Insulation resistance	Leakage current
Class I	RPE $\leq 1 \Omega$	RINS $\geq 1M \Omega$	IEL $\leq 5mA$
Class II		RINS $\geq 1M \Omega$	IEL $\leq 1mA$
Extension Leads	RPE $\leq 1 \Omega$	RINS $\geq 1M \Omega$	IEL $\leq 1mA$

4.3 Reference test condition

Unless otherwise specified, this specification is dependent on following condition.

- | | |
|--------------------------|---------------|
| (1) Ambient temperature: | 23±5°C |
| (2) Relative humidity: | 45 ~ 75% |
| (3) Attitude: | Horizontal |
| (4) AC power supply: | 240V, 50Hz |
| (5) Altitude: | 2000m or less |

Operating temperature and humidity range

0°C ~ +40°C Relative humidity: 85% or less (no condensation)

Storage temperature and humidity range

-20°C ~ +60°C Relative humidity: 85% or less (no condensation)

Rate voltage and frequency

Rated voltage: 240V ±10%

Rated frequency: 50 Hz ±1%

Maximum rated power

Approx. 9VA

Outer dimension and weight

Outer dimension: 185(L) × 167(W) × 89(D)mm

Weight: Approx. 1.2kg (only the instrument body)

Symbols used on the instrument:

 Equipment protected throughout by DOUBLE INSULATION or REINFORCED INSULATION

 Caution (Refer to the accompanying instruction manual)

 This instrument satisfies the marking requirement defined in the WEEE Directive (2002/96/EC). This symbol indicates separate collection for electrical and electronic equipment.

Measurement categories

To ensure safe operation of measuring instruments, IEC 61010 establishes safety standards for various electrical environments, categorized as CAT II to CAT IV, and called measurement categories.

O : Circuits which are not directly connected to the mains power supply.

CAT II : Electrical circuits of equipment connected to an AC electrical outlet by a power cord.

CAT III : Primary electrical circuits of the equipment connected directly to the distribution panel, and feeders from the distribution panel to outlets.

CAT IV : The circuit from the service drop to the service entrance, and to the power meter and primary overcurrent protection device (distribution panel).

5. Preparation before a measurement

5.1 Visual inspection

Before starting a measurement, user should undertake visual checks on the mains cord, case and that the correct type and rated fuse is fitted to the DUT. And also there should be no evidence of damage of a nature that may impair the electrical safety of the item.

5.2 Connection to main power supply

5.2.1 Connection of mains cord

Set the Function switch to VOLT Function, and connect the mains supply and the instrument with M7123 mains cord.

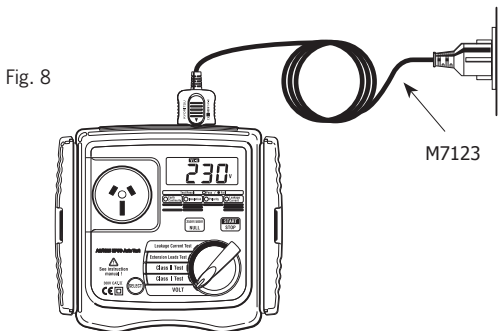

⚠ CAUTION

- Always be sure to check there is no abnormal conditions or damages on the instrument and cords. If any evidence of abnormality found, measurement shall be stopped immediately.
- The outlet of main power supply must have earth terminal.
- This instrument can be only connected to the commercial power of 240V+10%-10%, 50Hz.

5.2.2 Check the power supply voltage

There is no power switch and the instrument is immediately ready for use. Power supply voltage is displayed on the LCD. Please check the value, and when it is from 216V to 264V, the instrument can perform correct measurements. If the displayed value is out of above range, do not make a measurement.

⚠ WARNING

- When the voltage of main power supply is 265V or more, “HI-V” is displayed on the LCD.
- In that case, disconnect the mains cord of the instrument from main power supply.

5.2.3 Null setting

A criteria of judgment for Earth Continuity is $1\ \Omega$, and it is low value. So even the resistance of Test Leads will affect the measurement result. This instrument, M-6201A, can cancel the resistance of Test lead by pressing [Null|250V/500V] switch. The procedure of Null setting is shown below.

The Null function is not released even if power off the instrument, therefore, there's no need to do Null setting at every measurement. However, when replacing fuses or test leads, it is recommended to do Null setting again.

Procedure:

- (1) Set the function switch to Class I Test function.
- (2) Connect the mains supply and the instrument with M7123 mains cord.

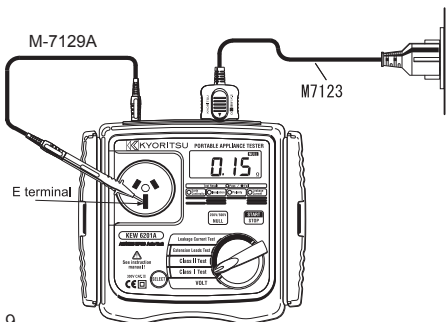

Fig. 9

- (3) Insert Test Lead with safety alligator clip (M-7129A) in to the E terminal of the instrument, and contact the tip of the Test Lead with the metal parts of the socket on the instrument.

Press **Null|250V/500V** switch with contacting the Test Lead and the metal parts, the resistance of Test Lead will be displayed on the LCD as shown above fig.10 for 2sec.

Then, the instrument cancels the resistance value of Test Lead and adjust the displayed value to "0.00" as shown below fig.10.

At this bout, **NULL** mark is displayed in the LCD.

Null setting cannot be done when a resistance is 3Ω or more.

A message "no" appears to indicate a resistance is exceeding the Null setting range.

Display at Null setting

Fig. 10

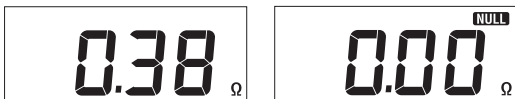

- (4) Null setting can be released by pressing **Null|250V/500V** switch for 2sec. The **NULL** mark on the LCD will disappear when Null setting is released.

Null setting and release can be done on Class I Test function only.

5.2.4 Voltage setting for insulation resistance measurement (How to change 250V and 500V)

- (1) Set the function switch to Class II Test function, and press the **Null|250V/500V** switch. Then the mark to indicate the selected voltage is shown on the LCD. By pressing **Null|250V/500V** switch, 250V and 500V can be changed over.

Fig. 11

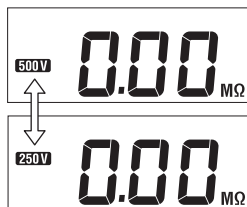

6. Measuring method

6.1 Class I Test

The purpose of the test carried out for Class I appliances is to check the insulation resistance between accessible conductive parts and connection of protective earth and between live wire parts and accessible conductive parts is within the range defined in the standards. To conduct the tests of protective conductor resistance and insulation resistance for DUT, connect the mains plug of DUT to the test socket (1) described in clause 3.4. INSTRUMENTS LAYOUT and PE probe terminal (5).

Use the following setups, depending upon the type of DUT.

Fig. 12

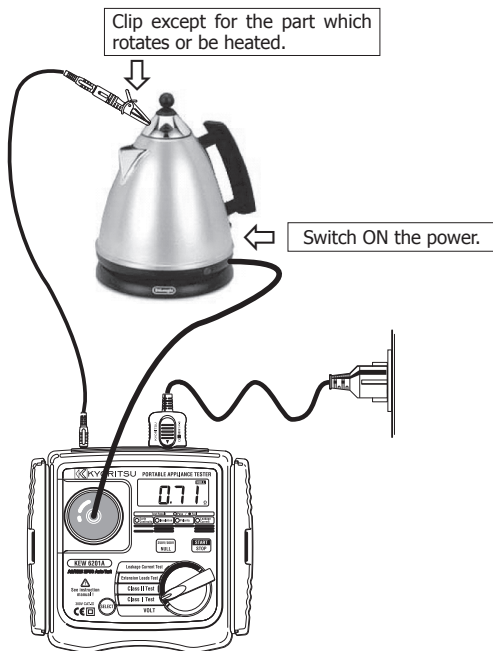

Class I Test Flowchart

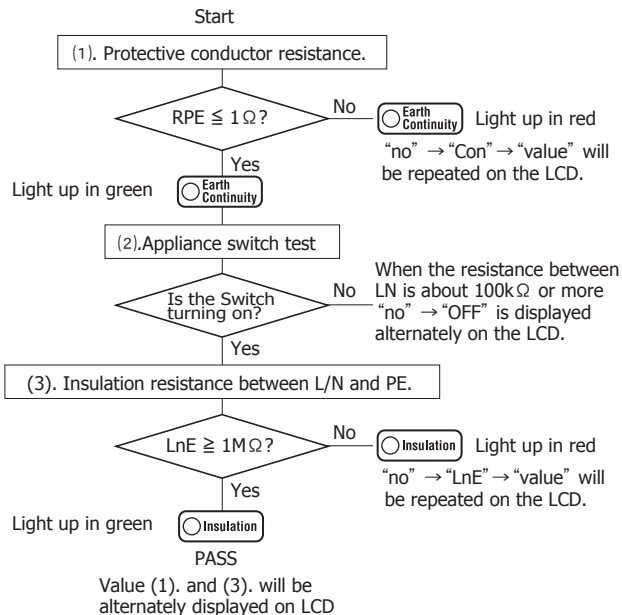

⚠ CAUTION

- Short-circuit between L/N and PE is doubt when "no" and "OFF" appears on the LCD in turns at the insulation resistance measurement of the Extension leads test for Class I & II while DUT is on. Testing should be immediately suspended.
- Follow the procedure described in 5.2-3 and do NULL setting before a measurement.
- Alligator clip must make good contact with the enclosure of the DUT.
- When the terminal is open or the resistance value exceeds measuring range, "OL" mark (over range display) appears on the LCD.
- Do not touch the device under test while testing is in progress. Since a high voltage of 500V, user may get electrical shock.

6.2 Class I Test (Select the Leakage current test)

Selecting “Class I test” while Select Switch is being pressed down initiates Leakage current test instead of Insulation resistance test.

In case of selecting Leakage current test, metal parts other than the heating or movable parts must be clipped with Test Lead M-7129A since the DUT activates. Pressing the **START/STOP** switch during Leakage current test stops the test immediately. To restart the test, press the **START/STOP** switch again 2 sec or later than the stop of the test. Then (1) Protective conductor resistance will be restarted.

Fig 12 indicates how to connect the devices.

Class I Test (Select the Leakage current test) Flowchart

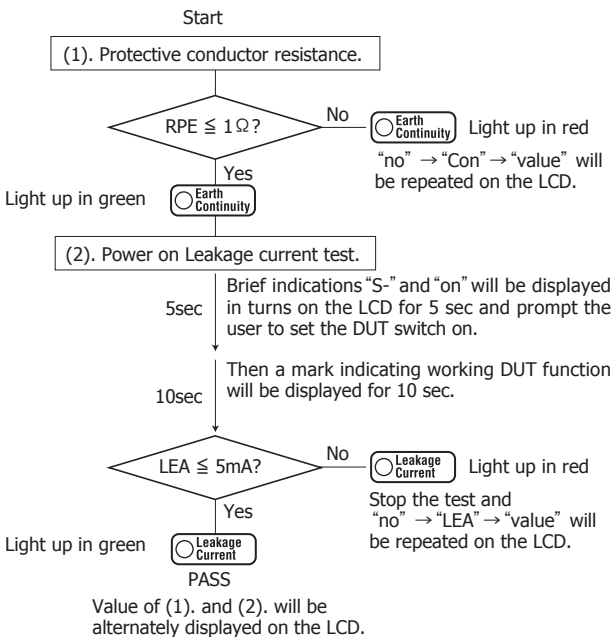

⚠ CAUTION

- When the terminal is open or the resistance value exceeds measuring range, “OL” mark (over range display) appears on the LCD.
- The test will stop. A message “Stp” appears on the LCD but values of Leakage current aren't displayed.

⚠ WARNING

- Operate a device and measure the leakage current flowing on it at Leakage current test function. Care should be taken not to touch with the heating or movable parts during tests. Extra care should also be taken to light and heat generated by the device.
- Firmly insert the plugs of DUT to the AU socket of this instrument. Plugs may be heated if Leakage current test is performed with improper connection.
- Do not connect/remove the plugs during Leakage current test. It may cause reading error. Do not use the instrument on the device which has a power of 2kVA or more.

6.3 Class II Test

The Class II appliances have the indication of “DOUBLE INSULATION” or the symbol of . Double insulation test is to check the insulation resistance of the appliances is within the range defined in the standards.

Fig. 13



Class II Test Flowchart

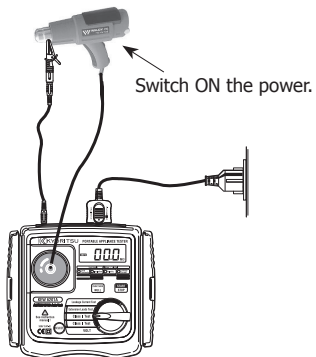
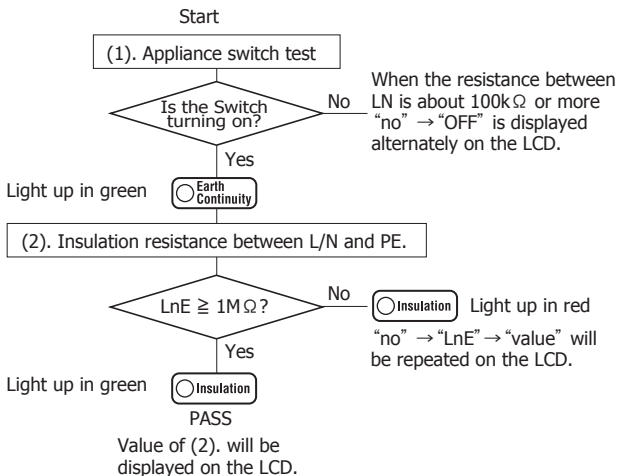

⚠ CAUTION

- Short-circuit between L/N and PE is doubt when "no" and "OFF" appears on the LCD in turns at the insulation resistance measurement of the Extension leads test for Class I & II while DUT is on. Testing should be immediately suspended.
- When the terminal is open or the resistance value exceeds measuring range, "OL" mark (over range display) appears on the LCD.
- Do not touch the device under test while testing is in progress. Since a high voltage of 500V, user may get electrical shock.

6.4 Class II Test (Select the Leakage current test)

When the function is set to Class II test while pressing Select switch, Power on leakage current test will be carried out instead of Insulation resistance test. When Leakage current test is chosen, DUT will operate actually. Clip a metal part of the machine tool except for the rotating part with Test Lead M-7129A. In order to stop testing the leakage current while measuring, press [START/STOP]. To start a test again, press [START/STOP] again after about 2 seconds or more from the stop. The test will be restart.

Class II Test (Select the Leakage current test) Flowchart

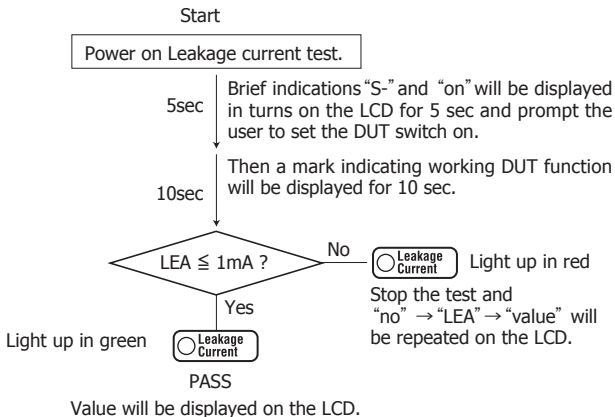

⚠ CAUTION

- When the terminal is open or the resistance value exceeds measuring range, “OL” mark (over range display) appears on the LCD.
- The test will stop. A message “Stp” appears on the LCD but values of Leakage current aren’t displayed.

⚠ WARNING

- Operate a device and measure the leakage current flowing on it at Leakage current test function. Care should be taken not to touch with the heating or movable parts during tests. Extra care should also be taken to light and heat generated by the device.
- Firmly insert the plugs of DUT to the AU socket of this instrument. Plugs may be heated if Leakage current test is performed with improper connection.
- Do not connect/remove the plugs during Leakage current test. It may cause reading error. Do not use the instrument on the device which has a power of 2kVA or more.

6.5 Extension Leads Test

- This test is for extension leads, and check:
 - Protective conductor resistance between accessible conductive parts and connection of protective earth.
 - Insulation resistance between L/N and PE.
 - Polarity check of the Line and Neutral terminal of plug and socket.
- Test procedure and the connection are as follows.

Fig. 14

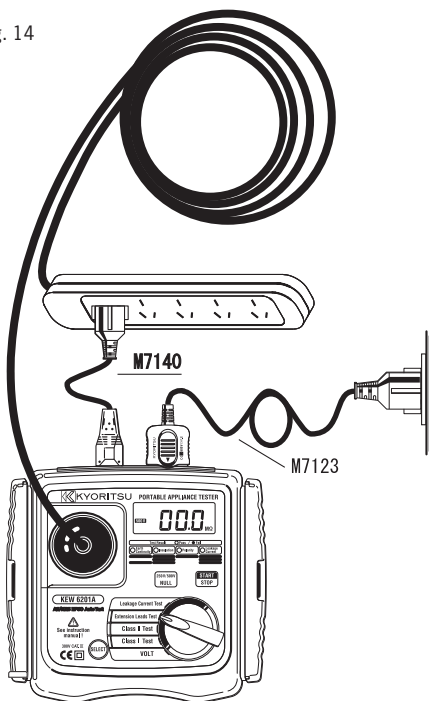

Extension Leads Test Flowchart
Start

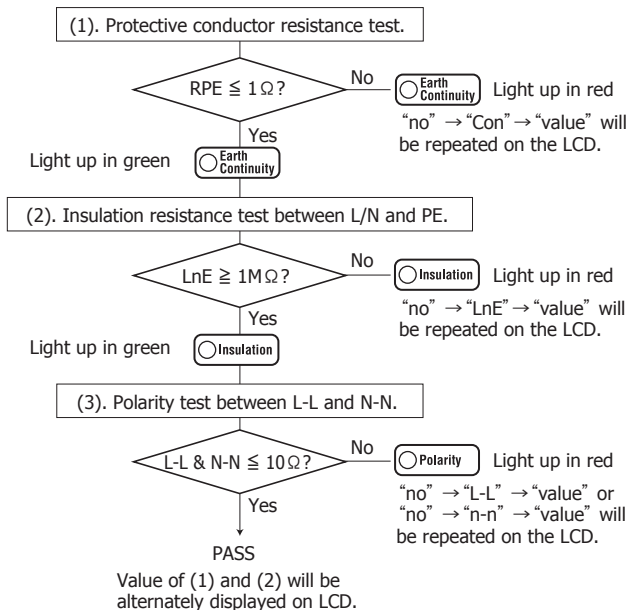

⚠ CAUTION

- Short-circuit between L/N and PE is doubt when "no" and "OFF" appears on the LCD in turns at the insulation resistance measurement of the Extension leads test for Class I & II while DUT is on. Testing should be immediately suspended.
- Follow the procedure described in 5.2-3 and do Null setting before a measurement.
- When the terminal is open or the resistance value exceeds measuring range, "OL" mark (over range display) appears on the LCD.
- Do not touch the device under test while testing is in progress. Since a high voltage of 500V, user may get electrical shock.

- When the function is set to extension leads test while pressing Select switch, Power on leakage current test will be carried out instead of Insulation resistance test.
 - Protective conductor resistance between accessible conductive parts and connection of protective earth.
 - Leakage Current test: Measure a leakage current by actually operating the appliance.

Extension Leads Test (Select the Leakage current test) Flowchart

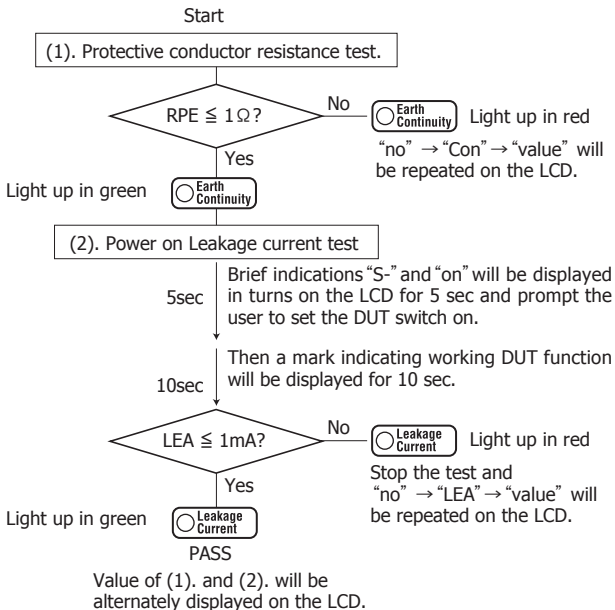

⚠ CAUTION

- When the terminal is open or the resistance value exceeds measuring range, “OL” mark (over range display) appears on the LCD.
- The test will stop. A message “Stp” appears on the LCD but values of Leakage current aren't displayed.

⚠ WARNING

- Operate a device and measure the leakage current flowing on it at Leakage current test function. Care should be taken not to touch with the heating or movable parts during tests. Extra care should also be taken to light and heat generated by the device.
- Firmly insert the plugs of DUT to the AU socket of this instrument. Plugs may be heated if Leakage current test is performed with improper connection.
- Do not connect/remove the plugs during Leakage current test. It may cause reading error. Do not use the instrument on the device which has a power of 2kVA or more.

6.6 Leakage Current Test

This function is to conduct the leakage current test separately with DUT operating actually. A leakage current only will be displayed on the LCD after DUT is electrified for 15 seconds.

LED will not light on even the Class I, Class II thresholds are exceeded.

- Set the function switch to Leakage Current Test position.
- Refer to the Fig12 or Fig13 for connection of an appliance.
- After set up is done, press **START/STOP** switch.
- Check the switch of DUT is ON.
- DUT will operate for 15 seconds, and the maximum value of the leakage current will be displayed on the LCD. If the leakage from the DUT is greater than 20mA then the 6201A should immediately stop the test.
- In order to stop the Leakage Current Test, press **START/STOP** switch again. The test will stop. A message "Stp" appears on the LCD but values of Leakage current aren't displayed.

Leakage Current Measment Flowchart

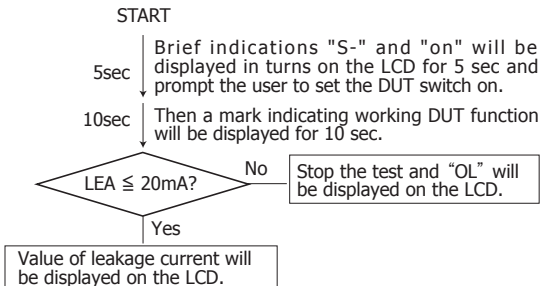

⚠ WARNING

- Operate a device and measure the leakage current flowing on it at Leakage current test function. Care should be taken not to touch with the heating or movable parts during tests. Extra care should also be taken to light and heat generated by the device.
- Firmly insert the plugs of DUT to the AU socket of this instrument. Plugs may be heated if Leakage current test is performed with improper connection.
- Do not connect/remove the plugs during Leakage current test. It may cause reading error. Do not use the instrument on the device which has a power of 2kVA or more.

7. Fuse replacement

When the fuse blows during use, please replace with new one according to below procedure.

Fig. 15

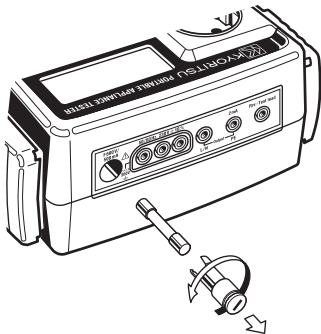

- (1) Use a flat head screwdriver and turn it about 45° to left and remove the fuse cap and fuse.
- (2) Remove the fuse from the fuse cap and replace it with new one.
- (3) Install the fuse cap and fuse again. At that point, the screwdriver groove shall be at about 45° turned to left from the initial position. Use the flat head screwdriver and turn it to right.
(The screwdriver groove will stop at the horizontal position.)

⚠ WARNING

- Be sure to remove mains cord from the instrument before replacing fuse.
- The fuse that user can replace is this fuse only. Never attempt to perform the other repairing.

⚠ CAUTION

- Please use the specified fuse (Fast acting type ceramic fuse: 600V/10A - $\Phi 6.3 \times 32\text{mm}$).
- For the specified fuse, purchase it by yourself or order it from our agency.

8. Services

If this instrument should fail to operate correctly, return it to your distributor. Please remember to give all the information possible concerning the nature of the fault, as this will mean that the instrument will be serviced and returned to you more quickly.

9. Case and strap assembly

Strap belt and probe case can be attached to the instrument as below. Pass the strap belt down through the side panel of the main body from the top, and up through the slots of the probe form the bottom. (Fig. 16). Pass the strap through the buckle, adjust the strap for length and secure.

Fig. 16

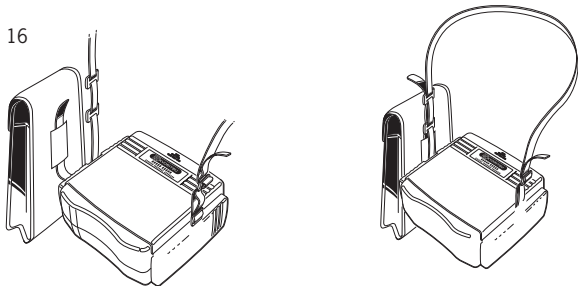

DISTRIBUTOR

Kyoritsu reserves the rights to change specifications or designs described in this manual without notice and without obligations.



**KYORITSU ELECTRICAL
INSTRUMENTS
WORKS, LTD.**

No.5-20,Nakane 2-chome, Meguro-ku,
Tokyo, 152-0031 Japan

Phone: +81-3-3723-0131

Fax: +81-3-3723-0152

Factory: Ehime

www.kew-ltd.co.jp